

Visual Corporate Identity Manual

Brand Application Guide

Communication and CSR Department

Version 1. 2023



Objectives of this manual

The Visual Corporate Identity Manual establishes the basic criteria and rules to be followed for correct application of the Aqualia brand.

It is aimed at all members of the company, but mainly at those involved in the design and implementation of any image or communication element.

We must make every effort to keep Aqualia's visual identity consistent.

We are a very large group of people working in the same organisation but very geographically diverse.

Together we need to ensure that each day we are building and nurturing a unique image of our Aqualia brand among our different target audiences.

A clear message and the same visual language that we all share to make a strong and competitive brand: Aqualia.

Proper compliance with the rules included in this manual by all of us helps create a uniform image of Aqualia, making it easier to distinguish the company and consolidate its market position.

Bearing in mind the general approach set out above, this manual essentially aims to meet two objectives:

- Establish and illustrate the rules for the proper use of the Aqualia brand, as well as the use of all aspects related to it (correct use of visual identity, colour, emplacements and typeface).
- Leverage examples to explain the correct application of the Aqualia brand, indicating correct and incorrect uses in each case.

Table of Contents

Download manual materials

You can download the logos and useful resources of this manual via the QR code on the pages where you see this box.



<https://www.aqualia.com/web/aqualia-en/aqualia-brand>

Please address any enquiries to the **Communication and CSR Department**.

1 Introduction

- 7 Aqualia Goal
- 8 Aqualia Positioning
- 9 Aqualia Values
- 10 The brand
- 11 Brand perception
- 12 The brand and its relational framework
- 13 Company name, trademark and brand

2 The brand and its application

- 16 Logo
- 17 Colours
- 18 Clear space
- 19 Minimum size
- 20 Claim
- 21 Colour versions
- 22 Misuses
- 24 Typefaces

3 Communication elements

- 28 Stationery
- 40 Signage
- 46 Vehicles
- 50 Identification of people
- 51 Apparel
- 52 Sports equipment
- 53 Trade fairs and events
- 55 Digital media
- 58 Signs

4 Related brands

- 62 The Aqualia brand in relation to others
- 63 Aqualia brand architecture
- 64 Building related brands
- 67 Coexistence of brands with endorsement
- 70 Brands without endorsement

intro

Aqualia Goal

Aqualia is one of the leading national and international operators specialising in the search for efficient responses and solutions to water supply, sanitation, treatment and re-use needs in the areas where it is present.

Aqualia professionals contribute with their daily work to ensuring the well-being of people and the progress of the communities where they work, providing a quality public service and ensuring the human right to water.

Aqualia Positioning



Aqualia has a clear business, ethical, social and environmental goal that positions it as a world leader in end-to-end water-cycle management and makes it a key player in delivering on the **UN's Sustainable Development Goals (SDGs)**.

In its commitment to society, Aqualia carries out actions linked to the development of the 2030 Agenda based on the financial, social and environmental sustainability of its activity. It also encourages dialogue and touchpoints with stakeholders and trains and reports to ensure that citizens are complicit in rational and efficient water use.

Aqualia's work is people-centric, viewing water as a public good and human right and striving every day to guarantee it.

Aqualia Values

Aqualia faces the challenge of efficient and innovative management across the end-to-end water cycle, focusing on its values as a company and building a business culture around its distinguishing features:

- **Expertise in the end-to-end water cycle management.** Aqualia's fundamental purpose is to deliver viable environmental, social and financial solutions and provide a quality service at all stages of the end-to-end water cycle.
- **Committed people focused on customer and goal.** The Aqualia staff comprises people who care for people and who demonstrate their strong vocation for public service every day, pushing past current and future challenges to enhance the lives of each community where the company is present.
- **Business ethics, transparency and integrity.** Aqualia operates under standards of business ethics and integrity. It is a benchmark in ethical management, maintaining relationships of respect, trust and equal opportunities with its professionals and different target audiences.
- **Service quality and efficiency.** Aqualia's commitment to society means constantly developing pioneering solutions that make life easier for people. A spirit of innovation and achievement is one of the pillars the company is built on.

- **Environmental engagement, awareness-raising and outreach.** Aqualia promotes people being informed and aware of environmental and social problems related to water management, either through educational tools, the promotion of sport or by supporting organisations aligned with its values.
- **Solvency and financial consistency.** Aqualia's national and international leadership position is shored up by its global risk management model that leads it to operate by leveraging the opportunities afforded by the water industry and established policies.
- **Social engagement.** Aqualia strives to build a fairer and more inclusive society through responsible water and sanitation use. Through its work it appeals to the population and invites people to reflect on how every small gesture can help improve the health of the planet.
- **Innovation.** The challenge of the technological age has seen Aqualia innovating from the outset, in systems, equipment and processes, powering innovation in sustainability and the company's role in the new circular economy model.

The brand



A brand is a fundamental and necessary **commercial** identification (or set of multiple identifiers) offering a product or service on the market in response to a sales **strategy**.

A brand is also **the spirit of a company** and its benchmark. All company decisions, actions and attitudes must convey the values that make up the brand, and these values must in turn be its support and reinforcement.

The influence of the brand reaches past its role in the service marketing process to ensure the consistency, motivation and evolution of the company.

Ergo, the Aqualia brand as such integrates the company's project and corporate culture. Its function extends beyond a communication mechanism, business asset, logo or service catalogue.

Aqualia is a global brand. It represents the company's visual identity across all its internal and external expressions, as a benchmark on the market and in its environment.

The company's aim is to establish a constant and strong presence of its Aqualia brand in each and every one of its business relationships and opportunities, designing negotiation strategies that include implementing the Aqualia brand across 100% of its corporate regulations. From there, any concession must be considered exceptional.

Brand perception

From a strong and clear local positioning and engagement, Aqualia is positioned as a global brand, both nationally and internationally.

The difference establishing a better or worse perception of a brand's image in relation to a service or product is an area where multiple variables come into play.

It all adds up: the citizen's mind gathers information on everything that stems from the same source and uses it to conceive a concept with which to act with regards the brand.

Customers, the media, government, bodies, entities and the company's workforce react differently depending on the image they associate with the brand.

By building a brand image a company constructs the present and consolidates the foundations of what the future will hold.

The brand and its relational framework

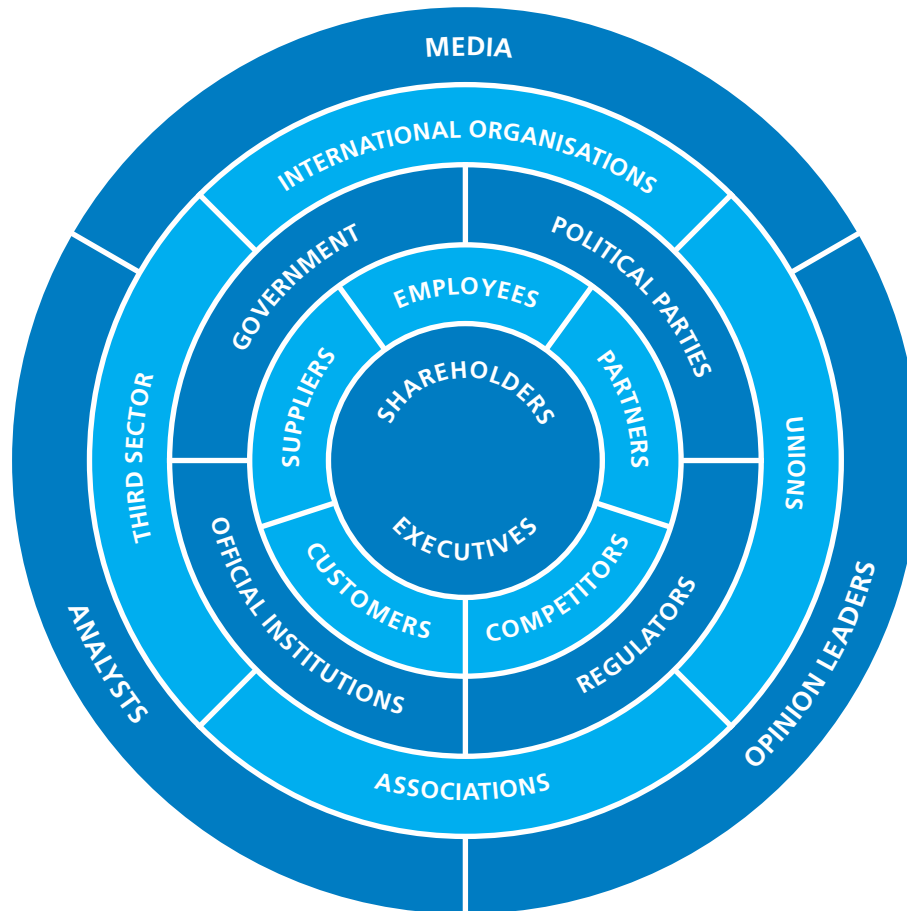

Managing the Aqualia brand is one of the company's most important objectives. Its function is to secure the company's identity on the market and with its different stakeholders by performing intensive analysis work and evaluating and crafting implementation techniques and tools that continually nurture the life cycle of the corporate brand.

Brand architecture is one of these techniques. As an integral part of a company's strategy, it is embodied in the forms of the business model itself. It normalises and defines the organisational structure that specifies the type, number, relationship and purpose of the brands within the business structure. It must therefore be consistent to strengthen the strategic impact, clarify and create value and synergies.

For Aqualia, the brand is a tier-one asset for the company's internal and external evolution. It generates value for stakeholders and the market and positions it with regards competitors. It also contributes to internal cohesion and increases pride in belonging.

Company name, trademark and brand

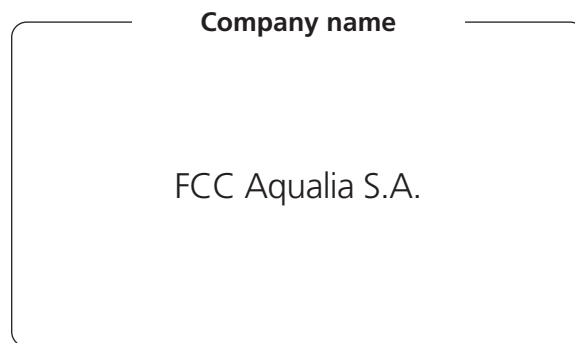

The **company name** identifies and individualises a corporate legal entity that has responsibilities, rights and obligations. This is the name under which business is done, contracts are signed and legal commitments are guaranteed. This is a mandatory legal concept applied for at the Companies Register and governed by the regulations of the Companies Register Regulation, Articles 395 to 419.

The **trademark** consists of a sign able to be visually represented in a way that identifies the company in commercial dealings and serves to distinguish it from other companies that carry out identical or similar activities. It is applied for at the Spanish Patent and Trademark Office and may or may not coincide with the company name. It is regulated by Law 17/2001 on Trademarks.

The **trademark, converted into a brand**, aims to highlight the market presence of a particular business activity. To give an example, we may refer on the one hand to the trademark or brand ZARA, the distinctive sign that clearly distinguishes the activity carried out by its holder on the market, and on the other hand the company name Inditex, S.A., the name of the firm that initially registered the trademark.

The role of the company name is usually limited exclusively within the framework of legal relations and not in market competition.

2

The brand and its application

Logo



Brand —•

Claim —•

Your water company

The brand comprises the logo, i.e., the word Aqualia, built from a simple yet characterful typeface in lowercase letters to make it more relatable, and the symbol formed by the two arrows or wings.

It presents a close, modern, young and dynamic image, essentially aimed at people; an image with its own character.

In the case of external communications by the company, the brand may be accompanied by the slogan or claim in the authorised languages, as we explain further on.

The claim “Your water company” applies to communications intended for the end customer (the person who is the recipient of the service provided by Aqualia).



Colours

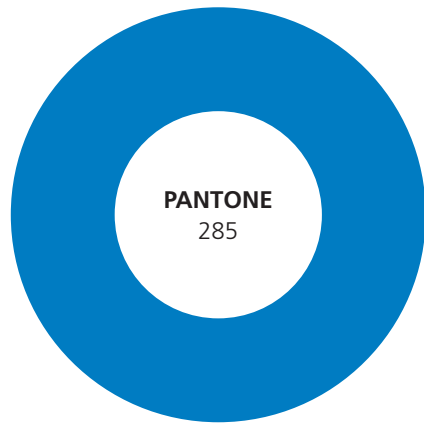

FOUR-COLOUR
c89 m43 y0 k0

RGB
r26 g117 b207

RAL
RAL 5015

LG Vinyl
LC6756-G

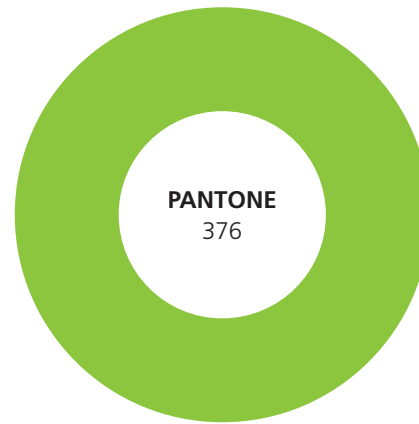

FOUR-COLOUR
c50 m0 y100 k0

RGB
r125 g186 b0

RAL
RAL 6018

LG Vinyl
LC6744-G

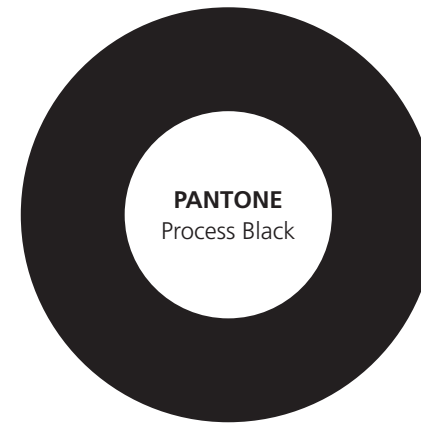

FOUR-COLOUR
c0 m0 y0 k100

RGB
r0 g0 b0

RAL
RAL 9017

LG Vinyl
LC682

Clear space

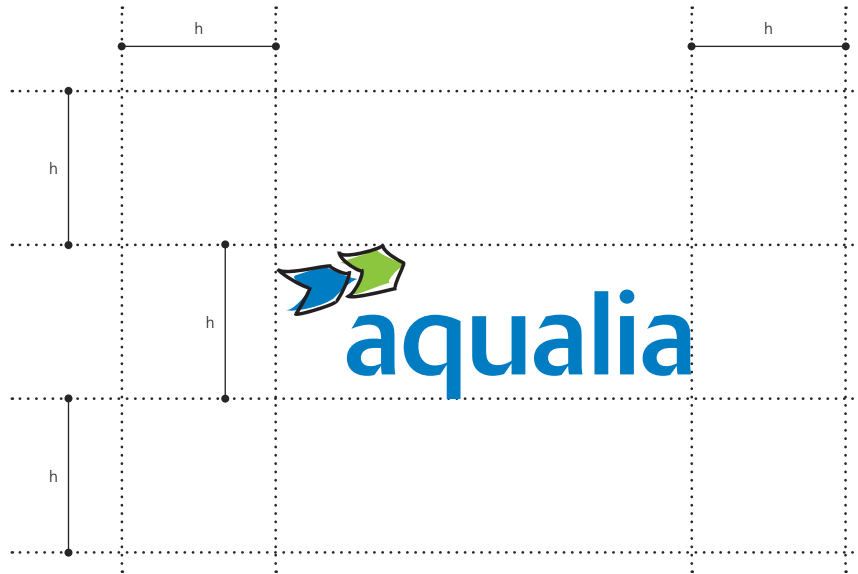

As a general rule, the logo's clear space is defined by its height.

The claim is an exception, placed at the specified and justified distance to the right of the logo.



Minimum size



Your water company



Your water company



Your water company



Your water company



Your water company



The logo must be displayed correctly. This is done by setting the minimum allowed sizes.

If only the logo is represented, without the claim, it is a minimum of 15 mm. If the two go together, the minimum size will be 22 mm.

If there is a need to apply it to a smaller size, the Communication and CSR Department must be consulted.

Claim



FOUR-COLOUR

c0 m0 y0 k60

RGB

r134 g134 b134

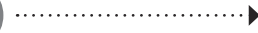

Tu compañía del agua



La teva companyia de l'aigua



A túa compañía da auga



A sua companhia de água



Your water company



Votre compagnie des eaux

For communications outside the company, the brand may be accompanied by the slogan or claim in the authorised languages.

The claim must always keep the same proportion with regards the logo. For this purpose, when it is used, it must be requested from the Communication and CSR Department.

As can be seen on the next page, the logo with the claim can also be represented in black, white or monochrome.

Colour versions

ON LIGHT COLOURS



These are the **only** colours in which the logo can be represented.

Corporate colours

On a white background or light colours or images.

White

On dark colours or images.

Grey, Corporate Blue or Black

When it must be represented in a single colour (monochrome version).

ON DARK COLOURS



MONOCHROME



Inappropriate use

THE LOGO MUST NOT BE DISTORTED



Any item the logo is used on, whether a pen, vehicle or internal note, should be considered a communication element. Care should therefore be taken to ensure the presentation is appropriate. Check that the image conveyed is what the company and its professionals deserve.

The logo occasionally appears distorted, giving an impression of carelessness that does not correspond to Aqualia and which must not be allowed.

The logo size often has to be modified for Word or PowerPoint documents. When this occurs, make sure the percentage of reduction or expansion is the same vertically as it is horizontally.

Inappropriate use

NO OTHER COLOURS OR PROPORTION CHANGES SHOULD BE USED



The Aqualia logo is the upshot of intense research in which each letter, space and colour has been carefully calculated.

It must therefore not be modified. This means it must be used on the different communication media according to the rules and with the visual elements proposed in this manual, with no retouching. The brand image may never be distorted and the logo will always be applied in the same way, colours and proportions, transmitting a solid and unmistakable vision.

Corporate typeface

FRUTIGER

ABC 123

Frutiger regular

ABCDEFGHIJKLMNOPQRSTUVWXYZ
abcdefghijklmnopqrstuvwxyz
1234567890!@#\$%&*?

*ABCDEFGHIJKLMNOPQRSTUVWXYZ
abcdefghijklmnopqrstuvwxyz
1234567890!@#\$%&*?*

ABC 123

Frutiger bold

**ABCDEFGHIJKLMNOPQRSTUVWXYZ
abcdefghijklmnopqrstuvwxyz
1234567890!@#\$%&*?**

***ABCDEFGHIJKLMNOPQRSTUVWXYZ
abcdefghijklmnopqrstuvwxyz
1234567890!@#\$%&*?***

Frutiger will be used as a corporate typeface. It is an elegant font that is easy to read.

It will be used across all communication elements requiring professional printing systems.

Recommended alternative typeface

ARIAL

ABC 123

Arial regular

ABCDEFGHIJKLMNOPQRSTUVWXYZ
abcdefghijklmnopqrstuvwxyz
1234567890!@#\$%&*?

ABCDEFGHIJKLMNOPQRSTUVWXYZ
abcdefghijklmnopqrstuvwxyz
1234567890!@#\$%&?*

ABC 123

Arial bold

ABCDEFGHIJKLMNOPQRSTUVWXYZ
abcdefghijklmnopqrstuvwxyz
1234567890!@#\$%&*?

ABCDEFGHIJKLMNOPQRSTUVWXYZ
abcdefghijklmnopqrstuvwxyz
1234567890!@#\$%&*?

The alternative typeface will be used in all office automation applications and digital presentations.

The Arial family appears in operating systems and is always available in any office. It will be used in spreadsheets, Word documents, PowerPoint presentations, etc.

For commercial tenders, the typeface can be modified to meet the required specifications.

3

Communication elements

Stationery - letter

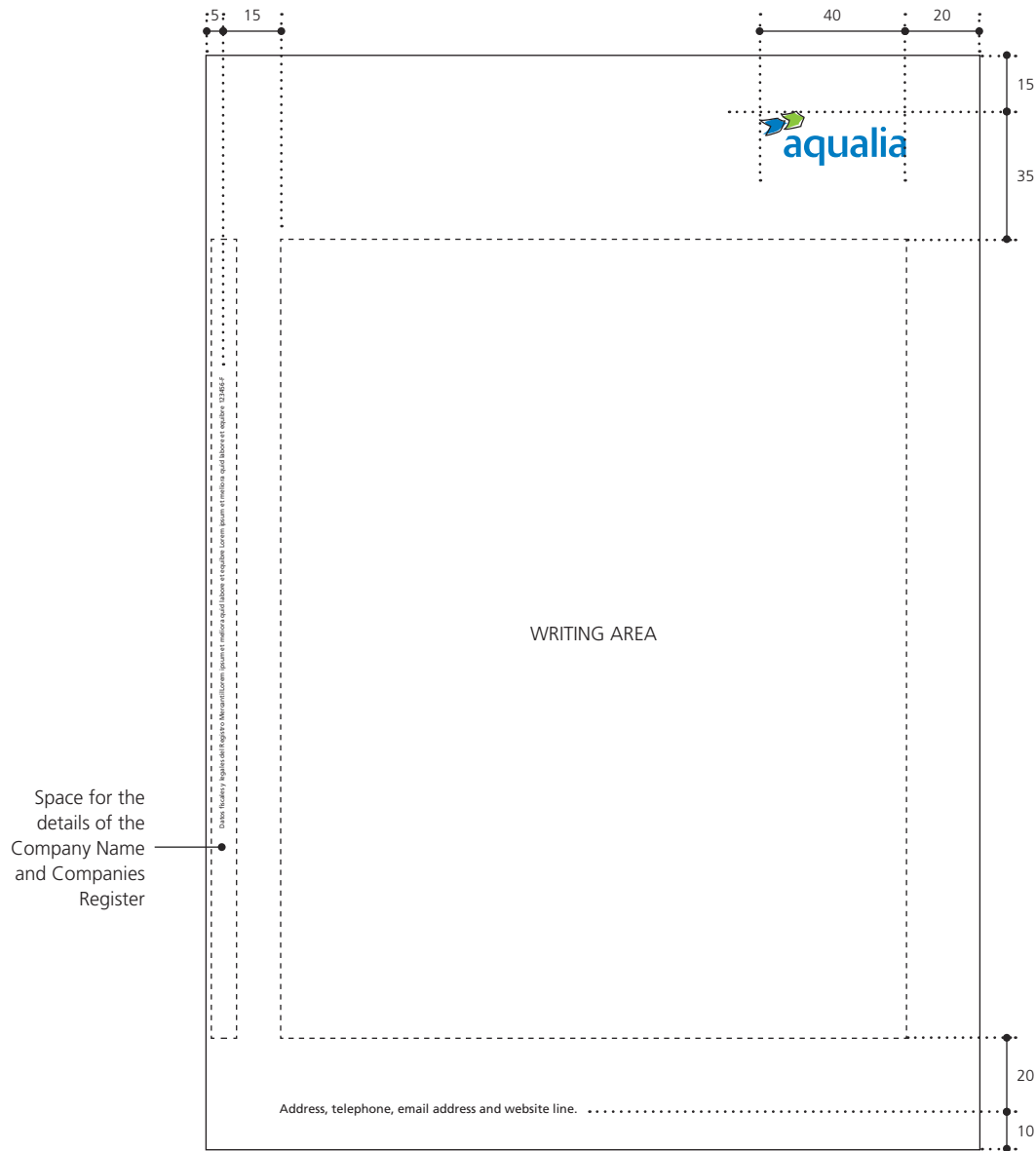

- Measurements 210 x 297 mm
- Eco-friendly White Offset Paper 90 g
- Printing inks P. 285 / P. 376 / Black
- Frutiger typeface

Stationery - second sheet

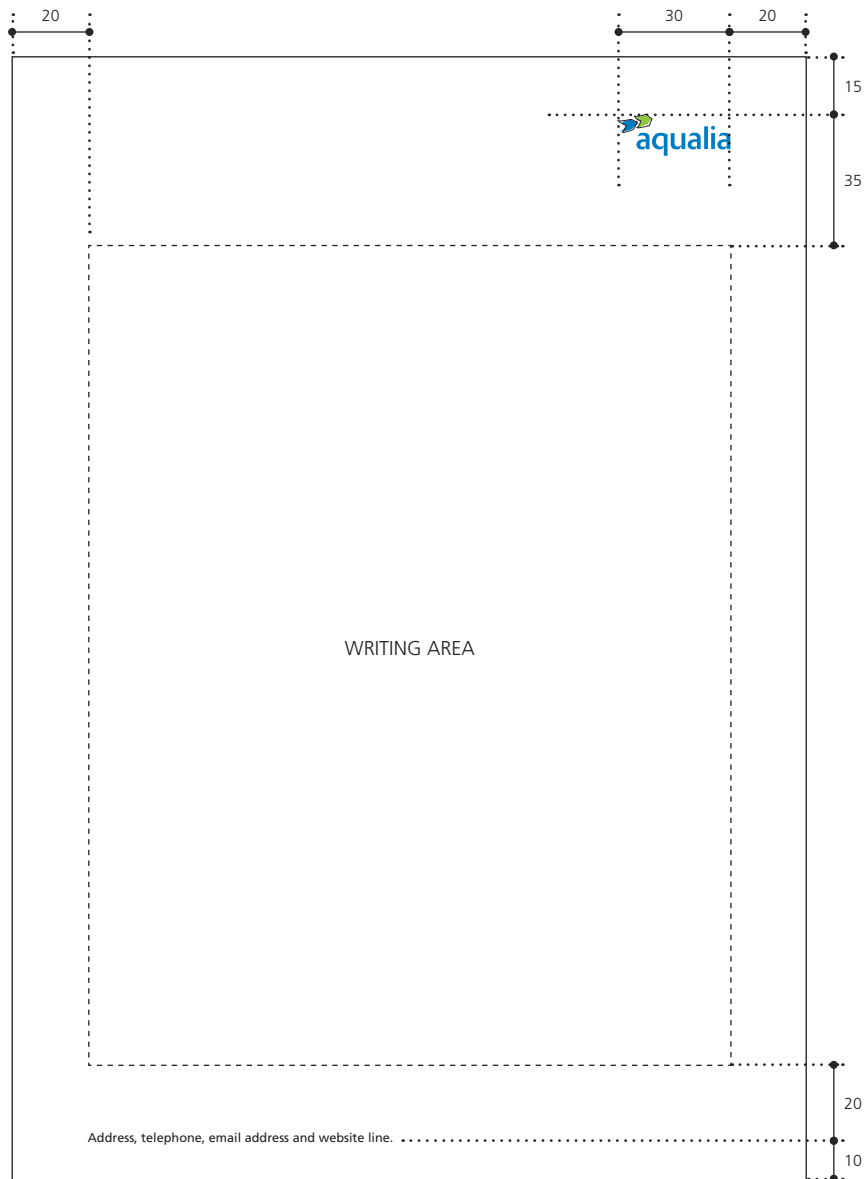

- Measurements 210 x 297 mm
- Eco-friendly White Offset Paper 90 g
- Printing inks P. 285 / P. 376 / Black
- Frutiger typeface

Stationery - internal note

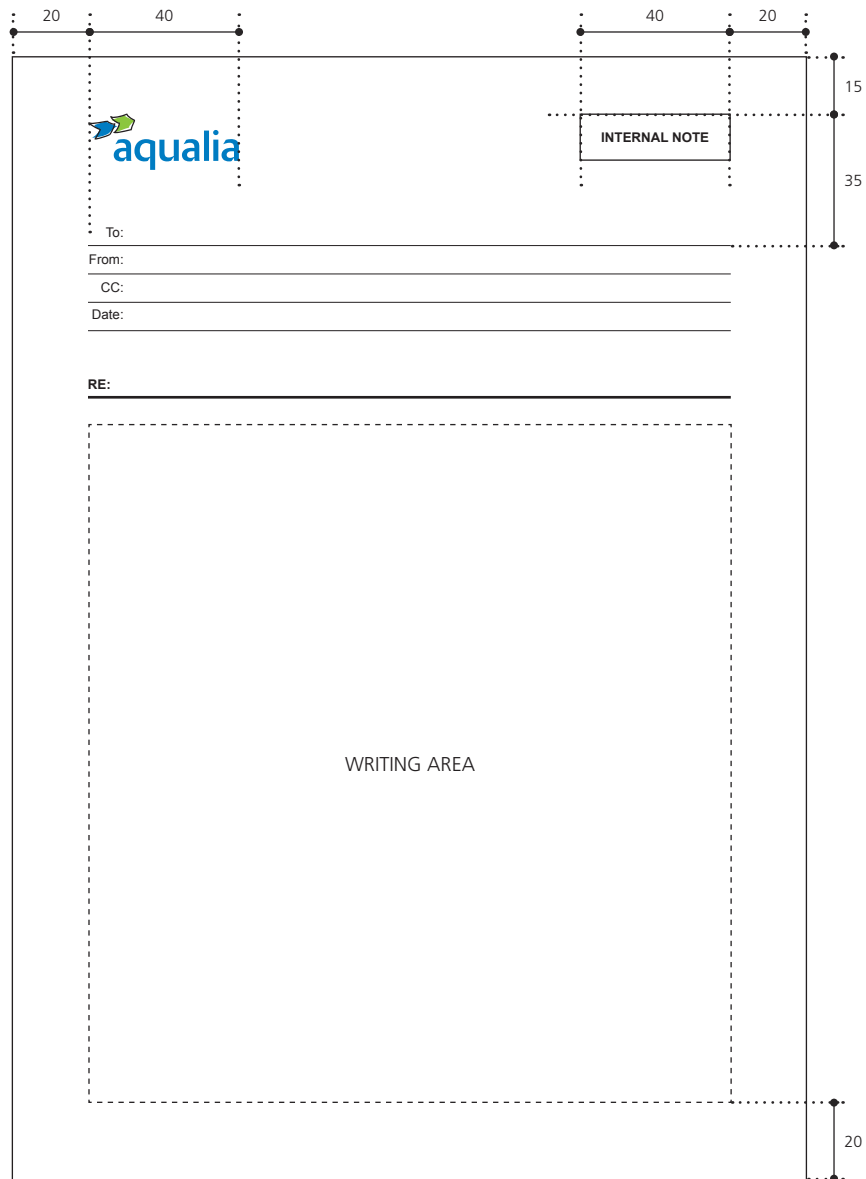

- Measurements 210 x 297 mm
- Eco-friendly White Offset Paper 90 g
- Printing inks Black
- Arial typeface

Stationery - corporate business card

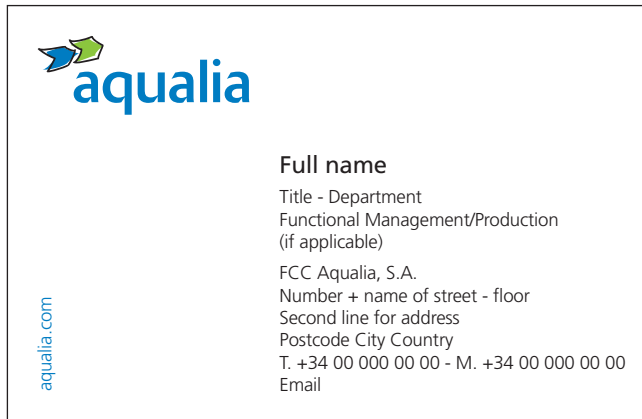

● Front

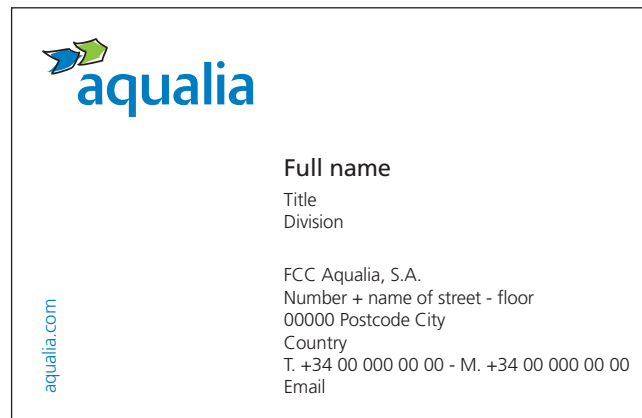

Back ●

- Measurements 85 x 55 mm
- Eco-friendly White Offset Paper 300 g
- Printing inks P. 285 / P. 376 / Black
- Frutiger typeface

Stationery - business card - activity area

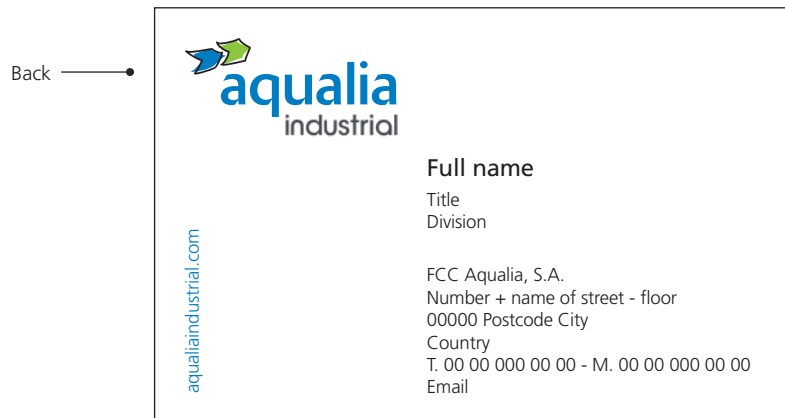
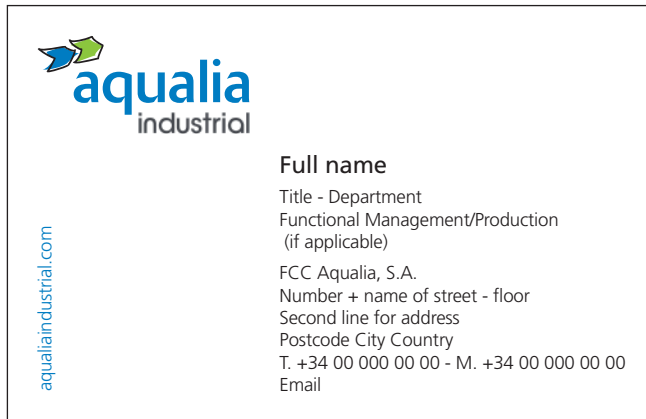

- Measurements 85 x 55 mm
- Eco-friendly White Offset Paper 300 g
- Printing inks P. 285 / P. 376 / Black
- Frutiger typeface

Stationery - display card - label

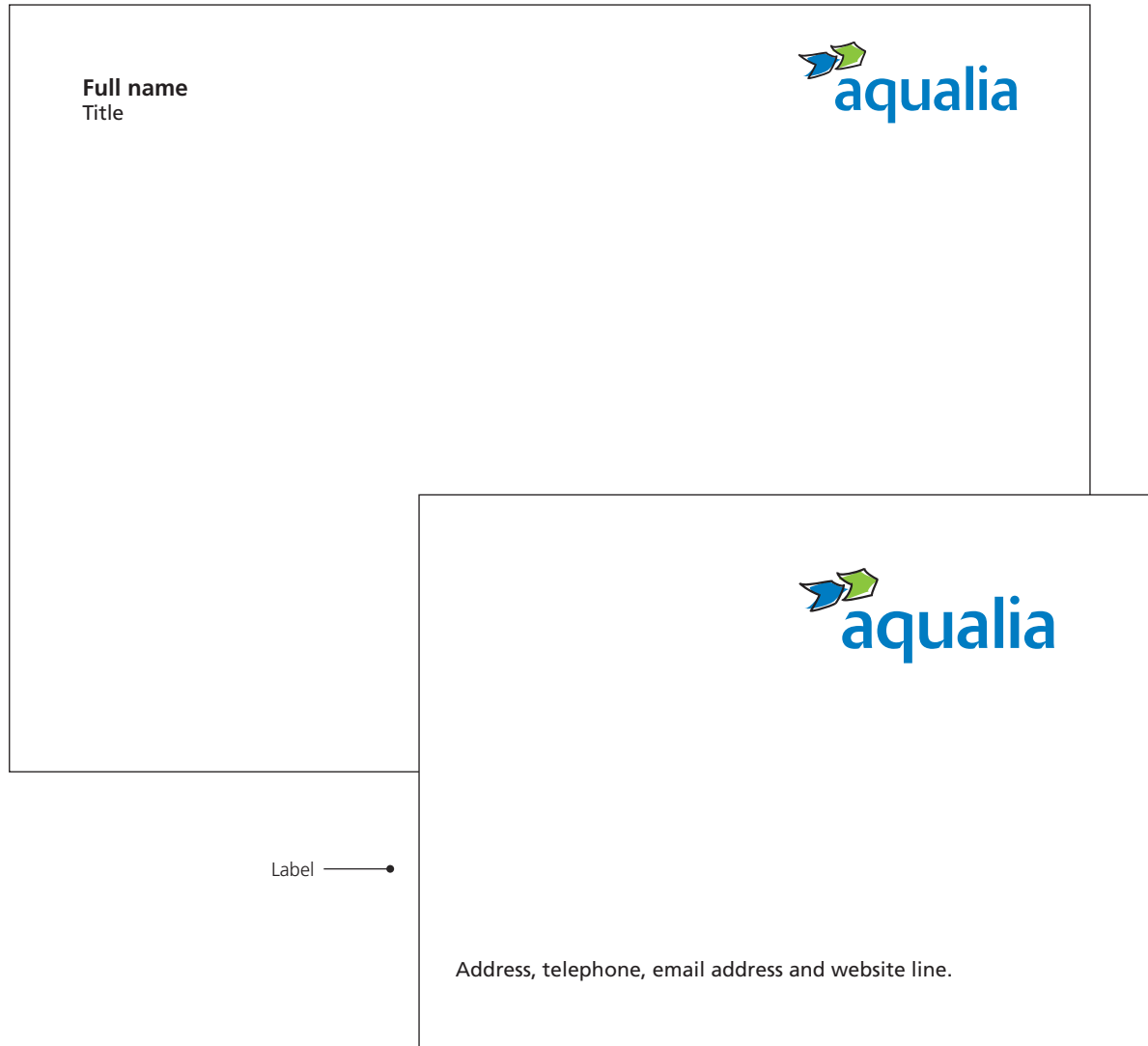

- Measurements 148 x 105 mm
 - Eco-friendly White Offset Paper 300 g
 - Printing inks P. 285 / P. 376 / Black
 - Frutiger typeface
-
- Measurements 102 x 76 mm
 - Type of adhesive paper
 - Printing inks P. 285 / P. 376 / Black
 - Frutiger typeface

Stationery - DL envelope

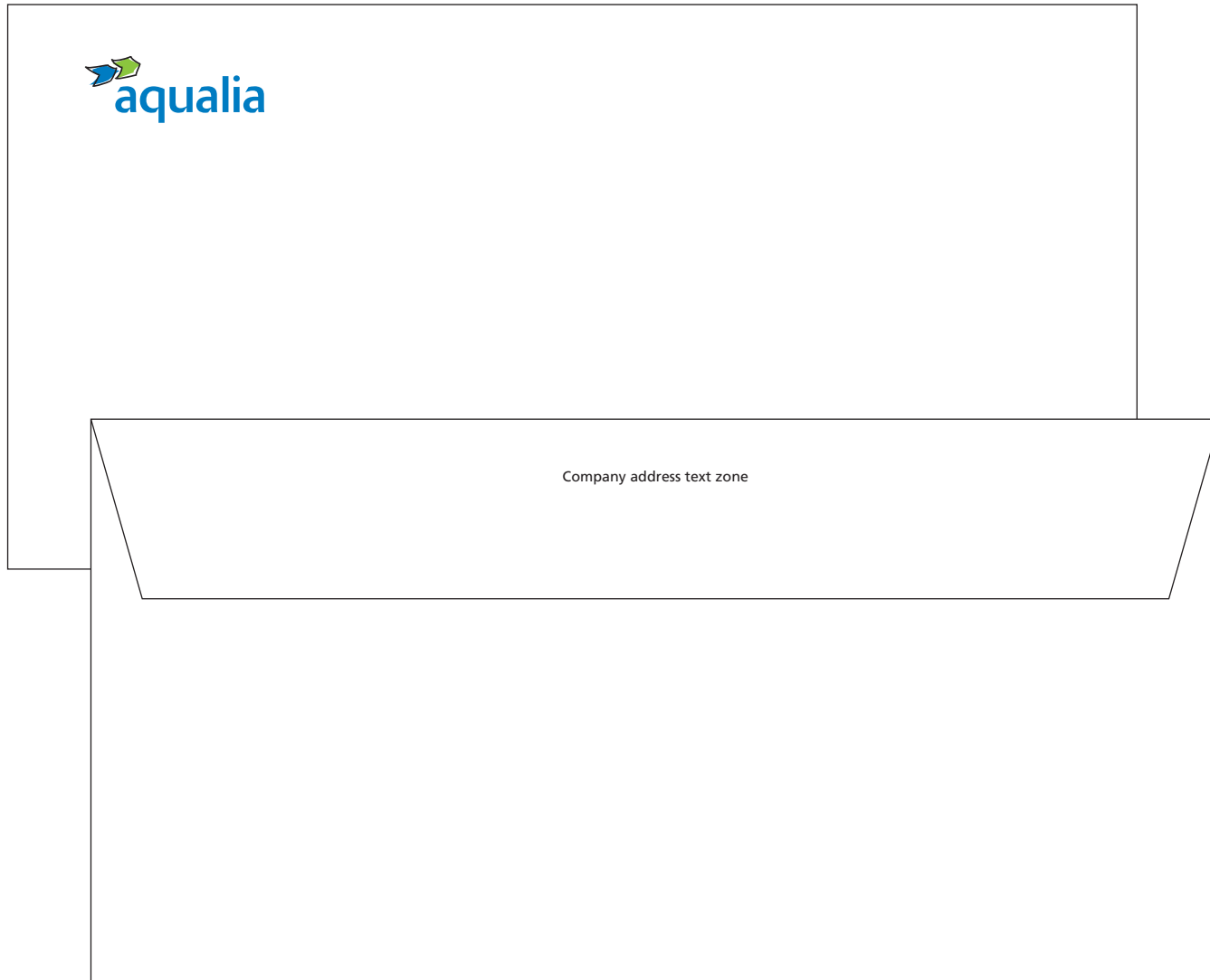

- Measurements 220 x 110 mm
- Eco-friendly White Offset Paper
- Printing inks P. 285 / P. 376 / Black
- Frutiger typeface

Stationery - C4 vertical envelope

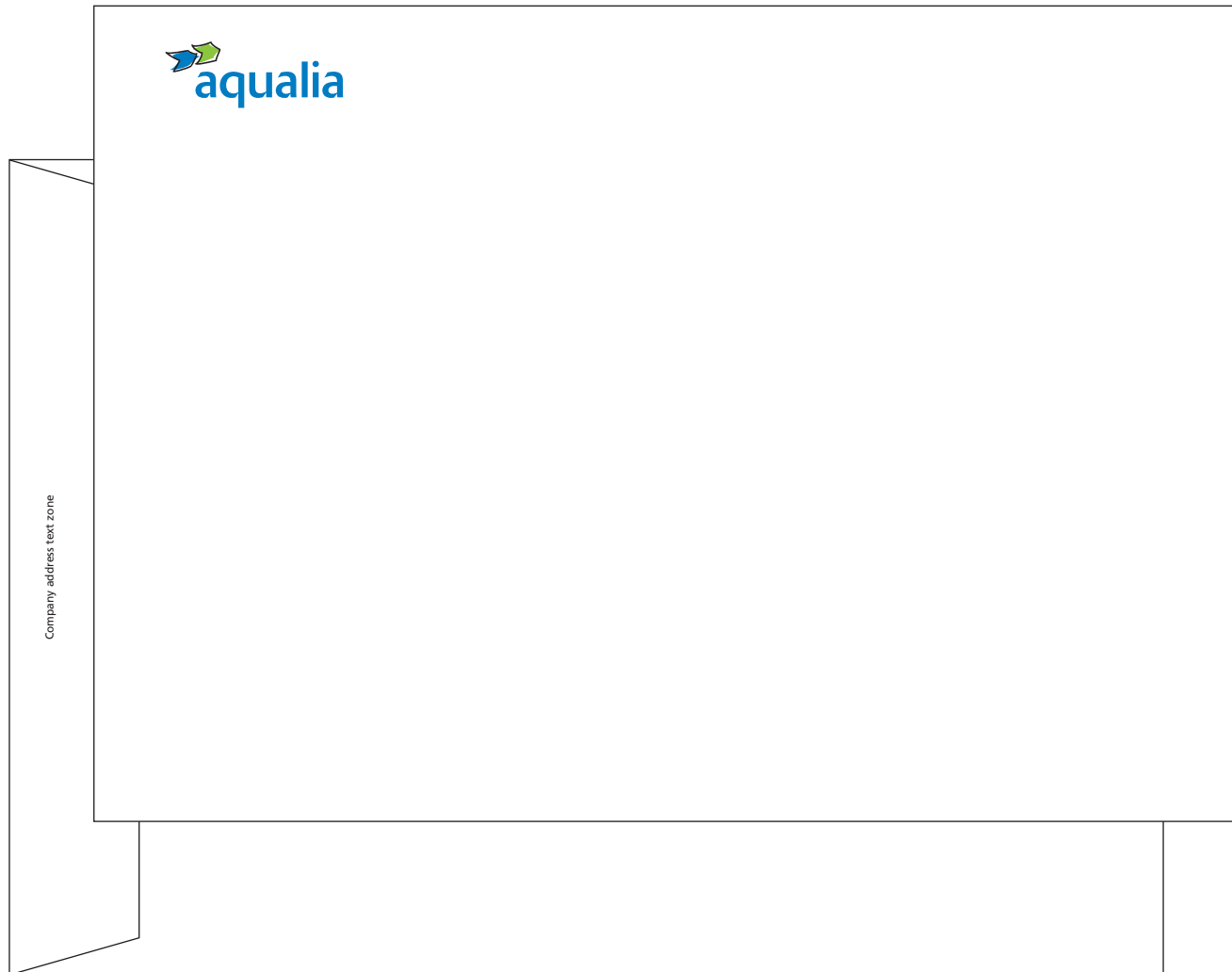

- Measurements 324 x 229 mm
- Eco-friendly White Offset Paper
- Printing inks P. 285 / P. 376 / Black
- Frutiger typeface

Stationery - C4 horizontal envelope

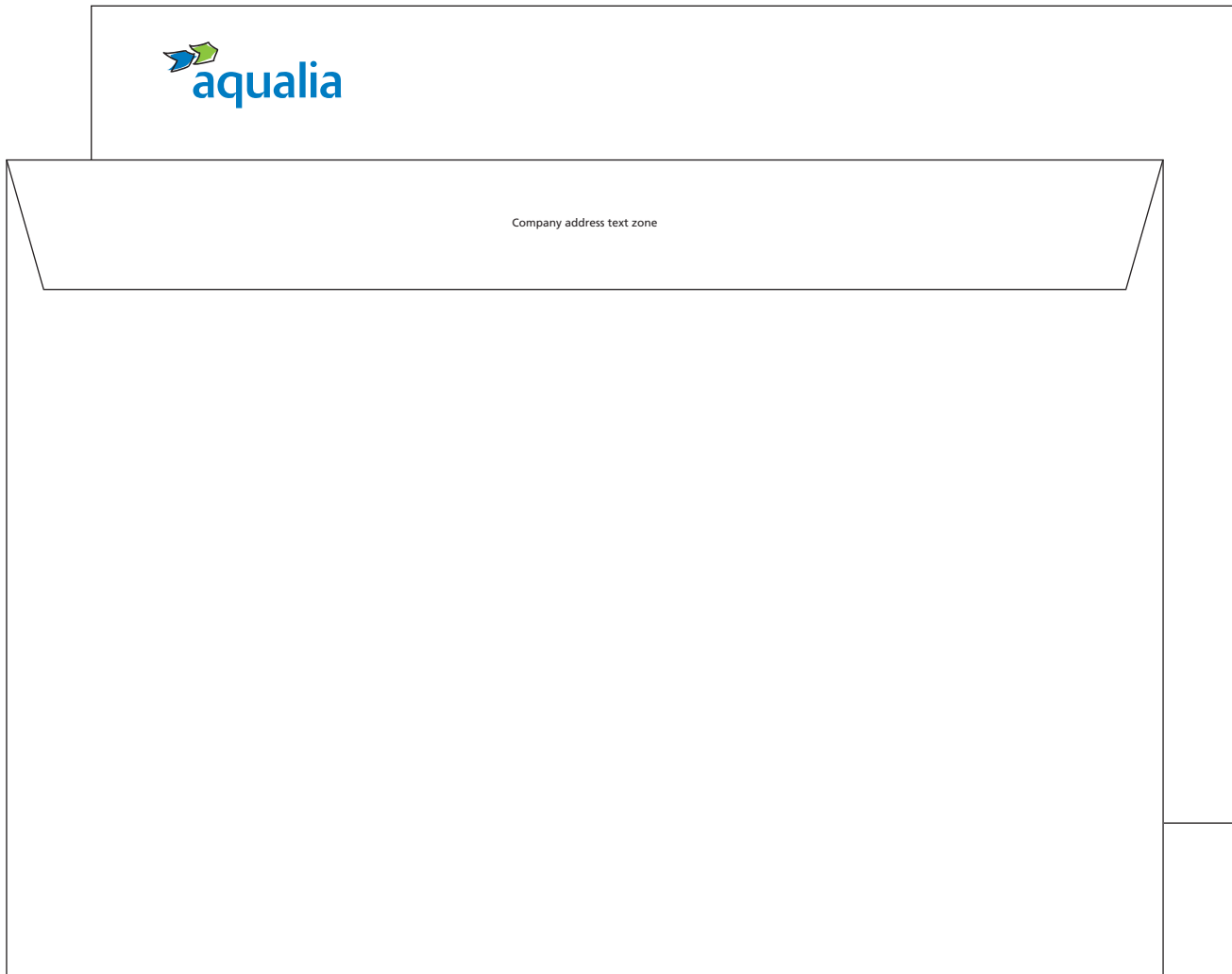

- Measurements 324 x 229 mm
- Eco-friendly White Offset Paper
- Printing inks P. 285 / P. 376 / Black
- Frutiger typeface

Stationery - folders

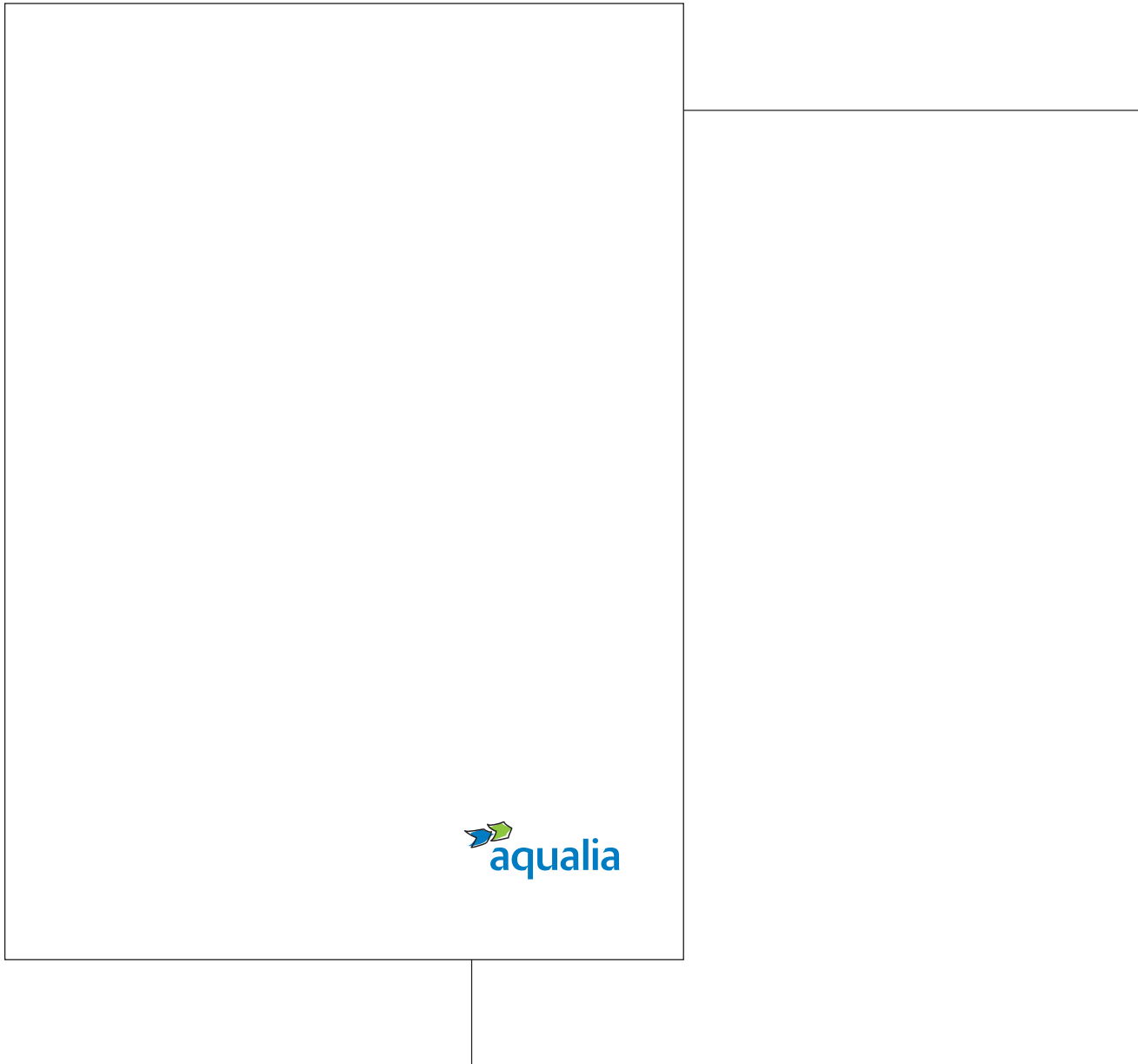

- Measurements 228 x 320 mm
- Eco-friendly White Offset Paper 250 g
- Printing inks P. 285 / P. 376 / Black
- White back cover

Stationery - stickers



- Measurements 120 x 90 mm
- Type of adhesive paper
- Printing inks P. 285 / P. 376 / Black
- Frutiger typeface

- Measurements 60 x 35 mm
- Type of adhesive paper
- Printing inks P. 285 / P. 376 / Black
- Frutiger typeface



Stationery - stamps and stamp pads

Company name

FCC Aqualia, S.A.

Zone

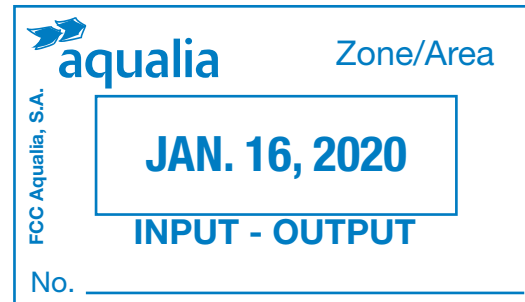

Department



Other



All stamps will bear the Aqualia brand and, if necessary, the company name.

Signage - distance chart

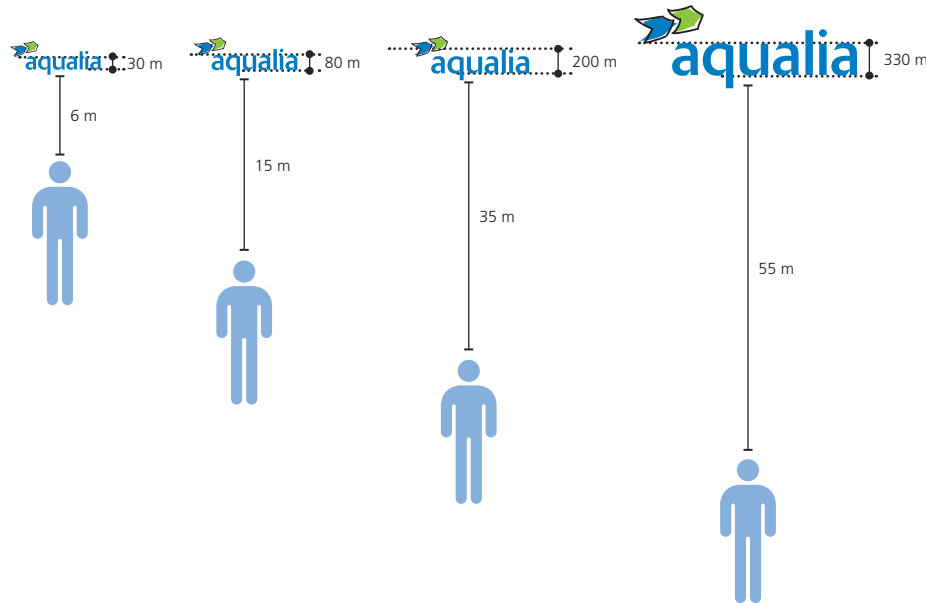

| Minimum sign height | Reading distance |
|---------------------|------------------|
| 30 mm | 6 m |
| 80 mm | 15 m |
| 200 mm | 35 m |
| 330 mm | 55 m |

Depending on its location, we can distinguish between indoor signage, i.e., that which is inside the office, and outdoor signage, outside the office.

Regarding reading distance it can be short, medium, long or very long distance.

An approximate relationship between these distances and the sign height is presented here.

Signage - short distance

Office door plate



Office internal directory

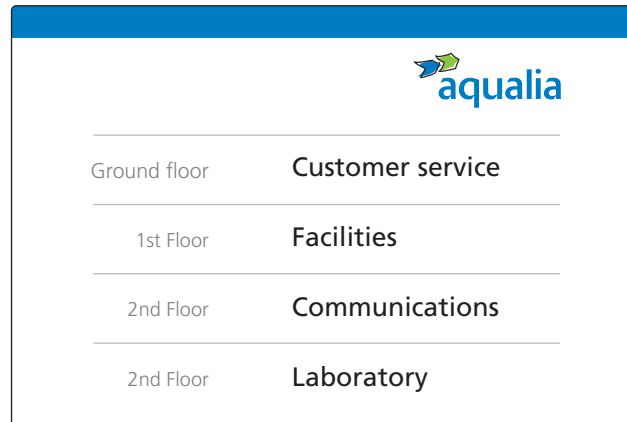

Office entrance plate

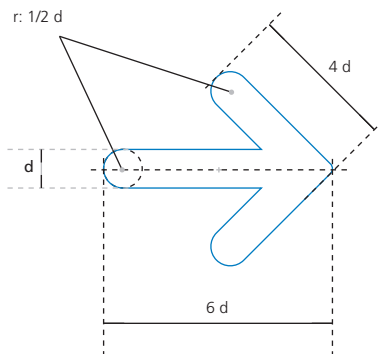
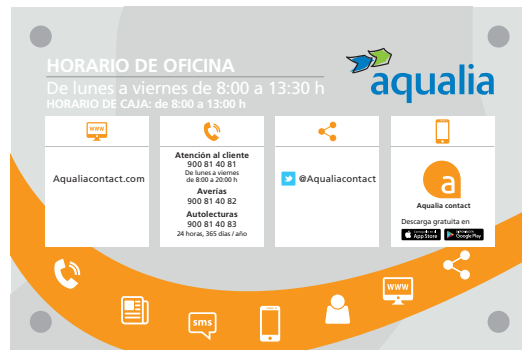
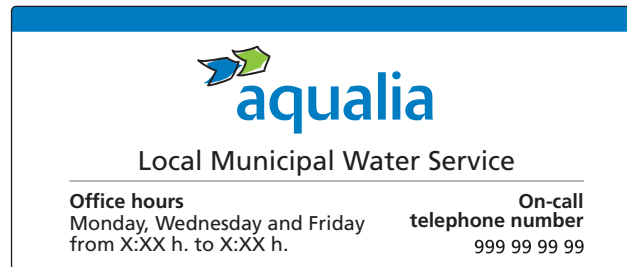

Wall plate

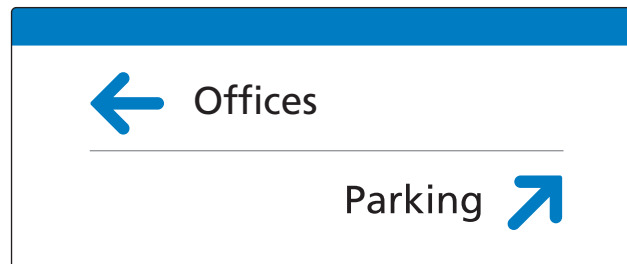

- Measurements: to be studied for each case
- Type of material: to be studied for each case, considering it does not undermine the brand image
- Typeface: Frutiger

Signage - medium distance

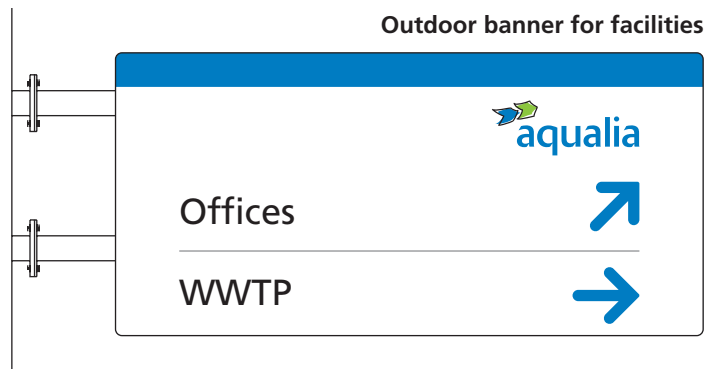

Manhole cover



Sewer cover

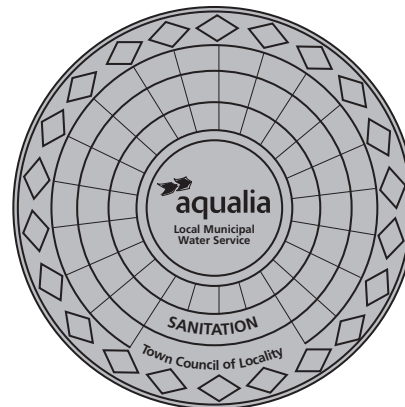

Water meter cover

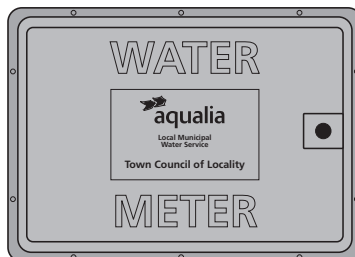

- Measurements: to be studied for each case
- Type of material: to be studied for each case, considering it does not undermine the brand image
- Typeface: Frutiger

Signage - medium distance

Works sign
or identification
of facilities



Worksite adhesives



- Measurements: to be studied for each case
- Type of material: to be studied for each case, considering it does not undermine the brand image
- Typeface: Frutiger

Work tape



Signage - medium distance

Work info tarp



- Measurements: to be studied for each case
- Type of material: to be studied for each case, considering it does not undermine the brand image

Site area demarcation tarp



Signage - front of building (fascia)



- Measurements: to be studied for each case
- Type of material: to be studied for each case, considering it does not undermine the brand image
- Typeface: Frutiger



FOR OFFICE DESIGN, SEE:

<https://www.aqualia.com/web/aqualia-en/aqualia-brand>



Company vehicles

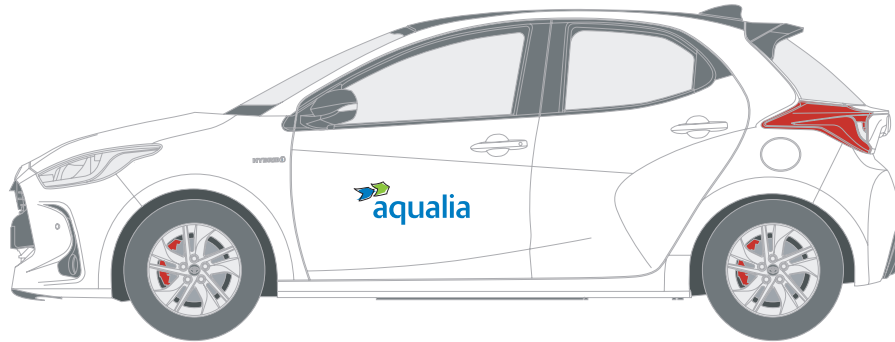

Example: Toyota Yaris

- To label other vehicle models, please see the Communication and CSR Department

DOWNLOADS



Download
Logos and resources here



Vehicles - Small van

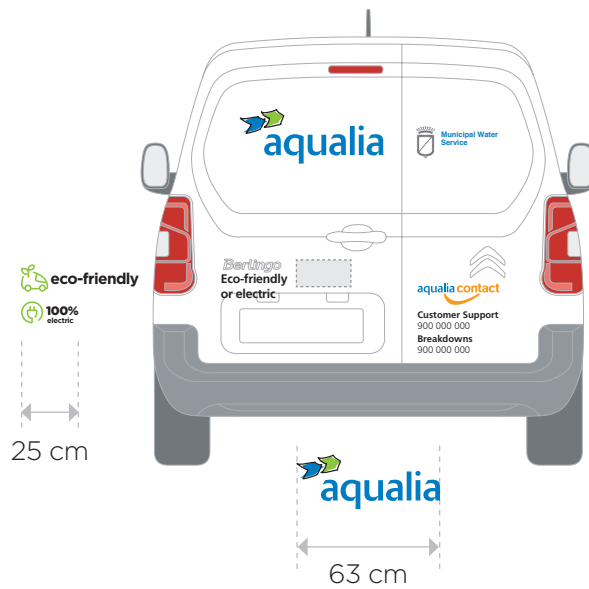
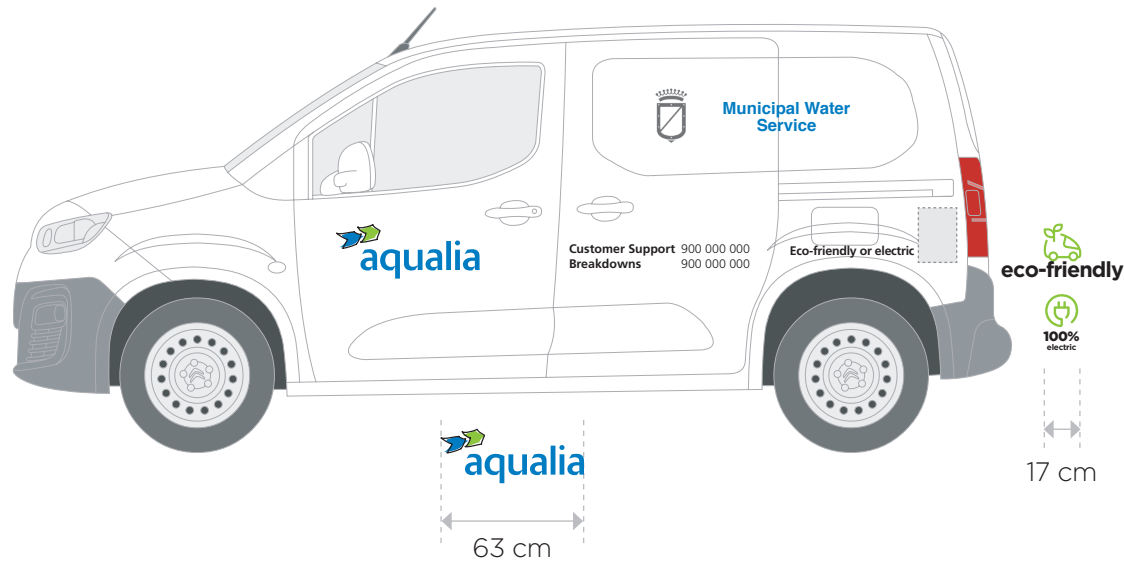

Example: Citroën e-Berlingo Van

- To label other vehicle models, please see the Communication and CSR Department



Vehicles - pick-up trucks

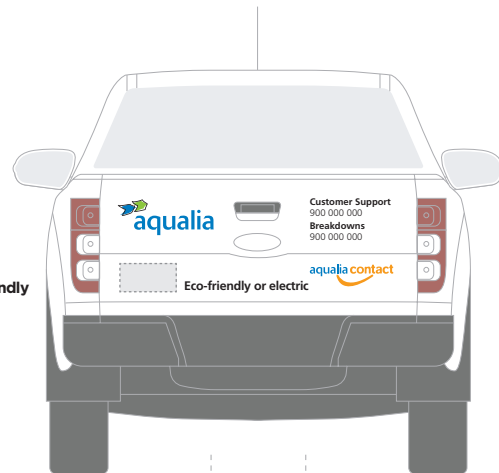
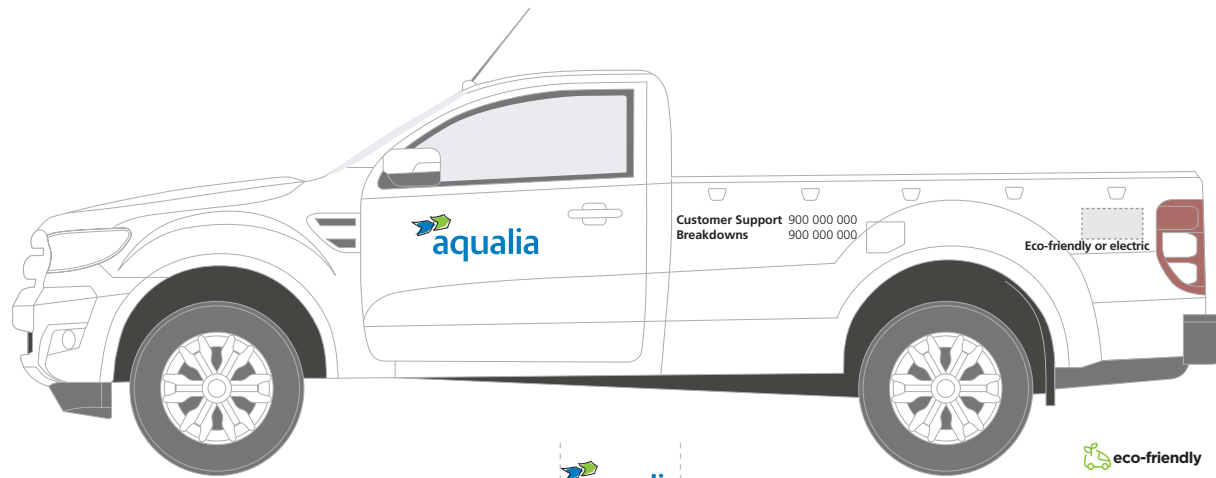

Example: Ford Ranger

- To label other vehicle models, please see the Communication and CSR Department

DOWNLOADS



Download
Logos and resources here



Vehicles - sanitation truck

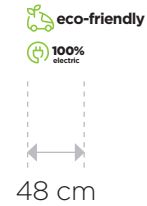

- To label other vehicle models, please see the Communication and CSR Department



Identification of people Apparel (Customer support and business activity)

Individual identifier

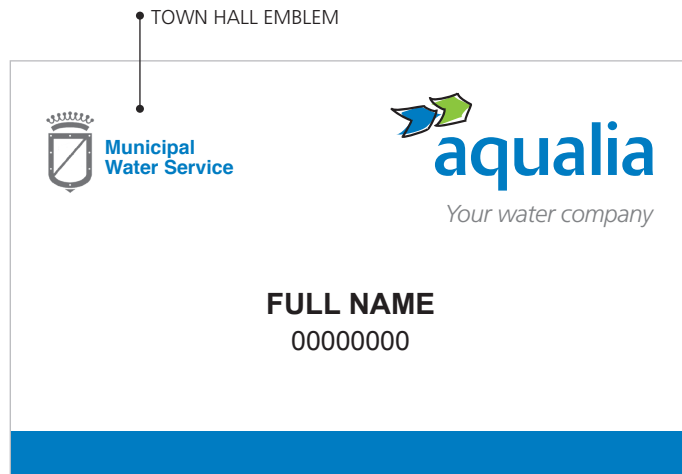

- Measurements: 90 x 55 mm
- Typeface: Frutiger/Arial

Softshell



Jacket



Women's shirt

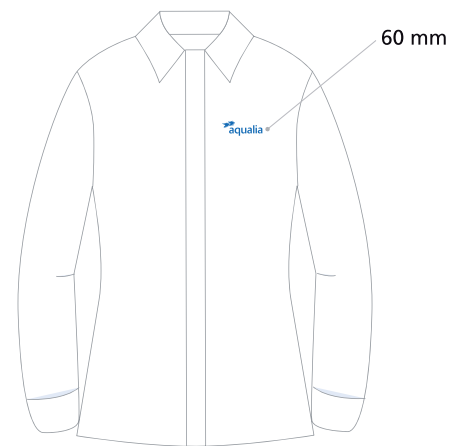

Men's shirt



Apparel

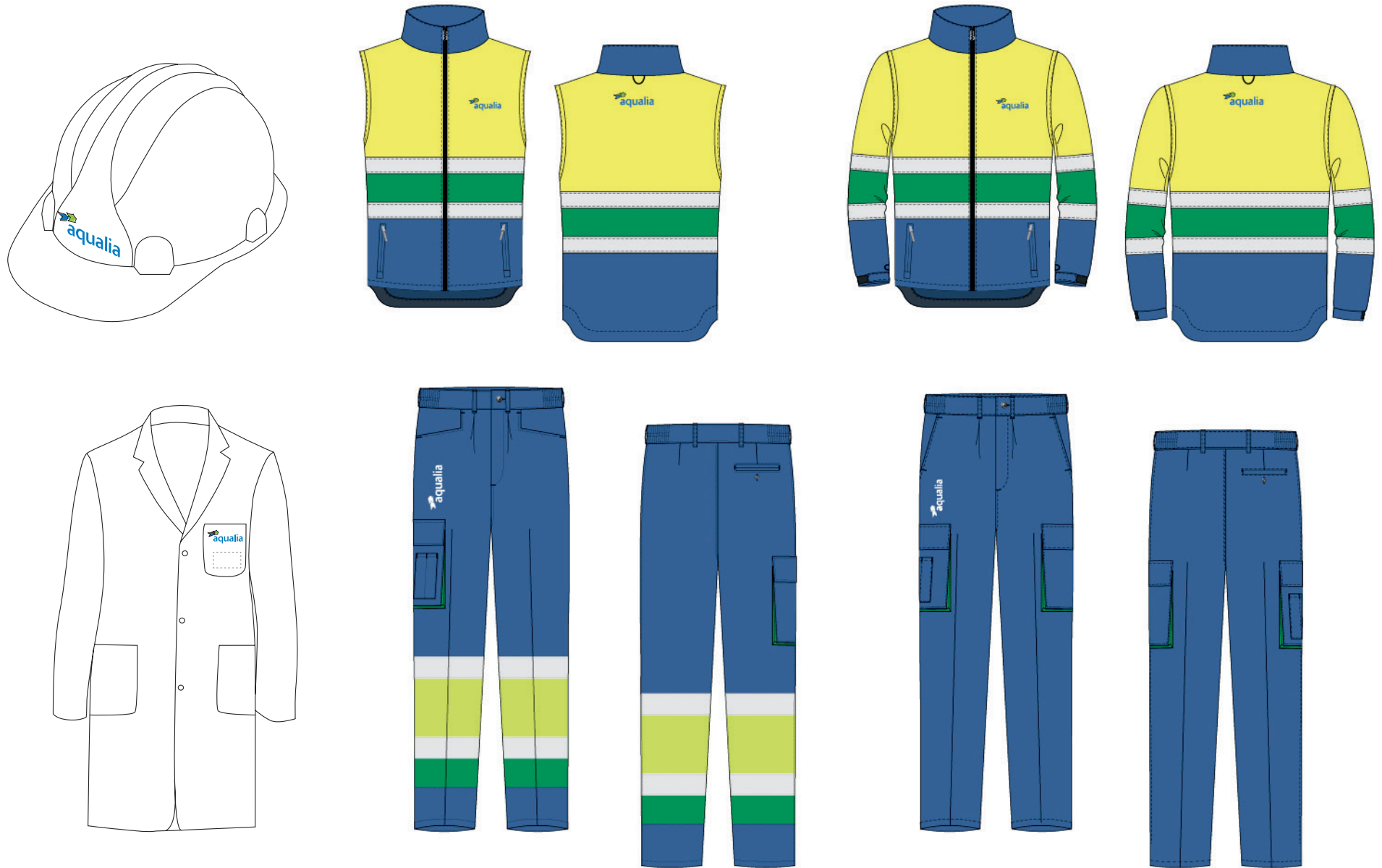

Sports equipment



The Aqualia corporate brand must be shown clearly on the different models of garments worn at sporting events, as illustrated in this example of a corporate sports t-shirt.

There are also other models of equipment for football, paddle tennis and cycling, among other sports. See the available designs at the link provided on this page.

Please see the Communication and CSR Department for any other type of sports equipment.

Trade fairs and events - Stands



Examples of stands



As a general rule, the following guidelines must be met when developing stands:

- Wall backgrounds and canvases in white or corporate blue.
- Corporate typeface.
- No more texts than necessary to convey the message.
- Use of italics is not admitted, except for claims and quotes.

Trade fairs and events - Promotional objects (examples)



Brand promotional objects are divided into three major groups:

- **Stationery**, notepads, pens, pen drives...
- **Utilities**, glass and aluminium bottles/tins, backpacks made from recycled plastic bottles, cotton bags...
- **Textile**, caps, t-shirts...

These materials must always be consistent with the brand's values, be related to Aqualia's performance and be sustainable and health-friendly.

Digital media - Corporate template for PowerPoint presentation

Monthly Activity Report
November 2018

Performance Report

| FCC Aqualia Group Consolidated | |
|--------------------------------|---------|
| (C) | 476.7 |
| (D) | (0.2) |
| | 0.5 |
| | 0.5 |
| TS | (0.7) |
| cash and cash equivalents | (0.7) |
| (B) | 1,283.3 |

EXTERNAL DEBT 1,658.6
Notes issued by FCC Aqualia and SmVak 1,565.6
Debts with credit entities 49.7
Finance lease liabilities 0.0

Training Direct Cost (euros)

| Category | Value (euros) |
|--------------------------|---------------|
| National & International | 865,309 |
| Training Bonus System | 395,278 |
| Real Cost | 470,011 |

Financial debt: 1,658.0 M euros

| Category | Value (M euros) |
|--------------------------------|-----------------|
| Other current-financial assets | 49 |
| Other financial expenses | 49 |
| Other financial liabilities | 1,565 |
| Other current-financial assets | 49 |

Index

- 1 Markets update
- 2 Financial Performance Report
- 3 Perimeter and Pipeline update
- 4 Consumptions and tariff Report
- 5 Litigations update
- 6 Operation and KPI's Report
- 7 Health & Safety Report
- 8 Compliance update

PowerPoint presentations must be developed on a corporate template.

Please contact the Communication and CSR Department if you do not have the template.



Digital media - email signature - Aqualia corporate signature

The diagram shows an email signature template enclosed in a dashed border. On the left, horizontal lines with arrows point to specific text elements, each accompanied by a font specification:

- Full Name** (Arial Bold 9 pt)
- Title – Area** (Arial Bold 9 pt)
- aqualia** (Arial Regular 7 pt)
- FCC Aqualia S.A. (Arial Regular 7 pt)
- Address: No. + name of street, building, floor (Arial Regular 7 pt)
- 00000 Postcode City Country (Arial Regular 7 pt)
- Tel. +00 000 000 000 (Arial Bold 7 pt)
- Mobile +00 000 000 000 (Arial Regular 7 pt)
- Email** (Arial Regular 7 pt)
- @ProfessionalTwitter (Arial Regular 7 pt)
- LinkedIn - YouTube - Twitter - Instagram (Arial Regular 7 pt)
- www.aqualia.com** (Arial Bold 7 pt)

Below the contact information, there is a **Confidentiality Notice** section containing a warning about the privacy of the email content and a request to consider the environment before printing.

Email signatures should follow the outlined model.

Because of the impact and importance they have on communication with the outside, they should not contain logos, images or any other graphic element.

Company areas and divisions will be visible in the job description.

Digital media - email signature - area of activity

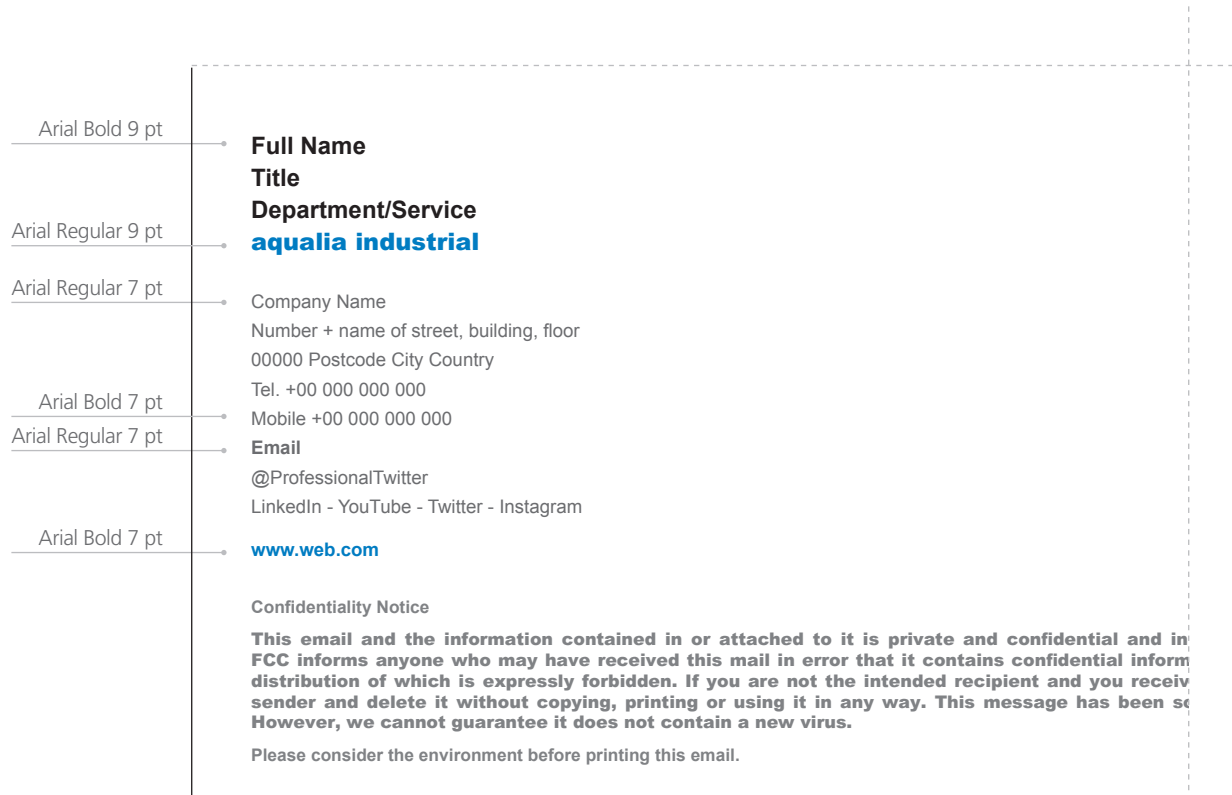

Email signatures should follow the outlined model.

Because of the impact and importance they have on communication with the outside, they should not contain logos, images or any other graphic element.

Office signs. Indoor areas



Example of signage for offices.

Please see the Communication and CSR Department for the complete collection and its possible uses.

Office signs. Customer Support Area



Example of signage for customer support offices.
Please see the Communication and CSR Department for the complete collection and its possible uses.

4

Related brands

A brand is a fundamental and necessary **commercial** identification (or set of multiple identifiers) offering a product or service on the market in response to a sales **strategy**.





























Generally speaking, Aqualia acts with a full brand presence across all acquisition and purchase processes of companies related to its activity, whether national or international.

Because of its status as a global brand, Aqualia interacts with other brands of different kinds and it is therefore sometimes necessary to create a related brand that meets the needs of all parties.

In these cases, a number of rules are established for building these new brands and their coexistence with the corporate brand.

Please see the Communication and CSR Department if you have any questions.

Aqualia brand architecture in the independent model

| Company name | FCC Aqualia S.A. | | | | | | | | | | | | |
|---|--|---|--------|--------|---|---|---|---|---|---|---|---|---|
| Corporate brand |  | | | | | | | | | | | | |
| Trademarks based on business relationship and local positioning (examples) | <table border="0"><thead><tr><th data-bbox="396 592 1077 687">Case 1</th><th data-bbox="1077 592 1615 687">Case 2</th><th data-bbox="1615 592 2143 687">Case 3</th></tr></thead><tbody><tr><td data-bbox="396 687 1077 847"></td><td data-bbox="1077 687 1615 847"></td><td data-bbox="1615 687 2143 847"></td></tr><tr><td data-bbox="396 847 1077 1007"></td><td data-bbox="1077 847 1615 1007"></td><td data-bbox="1615 847 2143 1007"></td></tr><tr><td data-bbox="396 1007 1077 1278"></td><td data-bbox="1077 1007 1615 1278"></td><td data-bbox="1615 1007 2143 1278"></td></tr></tbody></table> | Case 1 | Case 2 | Case 3 |  |  |  |  |  |  |  |  |  |
| Case 1 | Case 2 | Case 3 | | | | | | | | | | | |
|  |  |  | | | | | | | | | | | |
|  |  |  | | | | | | | | | | | |
|  |  |  | | | | | | | | | | | |
| Trademarks identifying a business with a projection abroad |  | | | | | | | | | | | | |

Building related brands



Case 1

Aqualia in the case of national or international business purchases or acquisitions with a 100% stake

The brand in this case will always be Aqualia, although where the acquired brand has real value and importance a period of transition is established from the acquired brand name to our one. After this time, the brand will become Aqualia.

- Aqualia logo typeface: Delta Jaeger.
- Unique corporate icon of Aqualia (wing shape).
- The name is assigned by the specific entity, which usually follows local criteria.
- Aqualia corporate colours: 

Building related brands



EXAMPLE



SITUATION 1

SITUATION 2



EXAMPLE



Case 2

Aqualia in relation to mixed enterprises (relations with municipalities) and joint ventures

In cases where the Aqualia brand cannot be used for reasons of the negotiations themselves, the following guidelines are established to create a subsidiary brand where the name must always contain the word 'aguas de' or 'aqua' and keep certain corporate features.

- Aqualia corporate typeface: Frutiger.
- Icon assigned by the entity to a local element.
- The name is assigned by the specific entity, which usually follows local criteria.
- Aqualia corporate blue and new colour
- Pantone 5415 / c56 m11 y0 k43 / r96 g127 b154:

Case 3

If the negotiations result in the creation of a completely new brand, an attempt must be made to conserve Aqualia's corporate colours.

- The typeface does not necessarily have to be the Aqualia corporate one.
- Local icon.
- The name assigned by the specific entity, which usually follows local criteria.
- Aqualia corporate colours:

Building related brands

Related brands
that define goods
or services

aqualia LAB

aqualia contact

aqualia live

Related brands
that define internal
projects

Beaqualia

In these cases, the Aqualia brand logo must always be used, in its colour and without its image type (its “wing” characteristics) accompanied by an identifier of the product or service it will provide.

In communication materials, these brands must coexist with the Aqualia corporate brand in all cases.

Please see the Communication and CSR Department to create or modify these types of identifiers.

Coexistence of brands with endorsement



Below is the coexistence relationship for brands related to the corporate brand.

Brands with Aqualia endorsement

For new brands resulting from business relations in which Aqualia has the higher stake, the corporate brand must appear as a support on material where appropriate.

Coexistence of brands. Examples

Works sign or identification of facilities

Business card

Ulput nibh eliquamcommy nos aliquat. Duis nullandre vulla faccum
 Ad tie dolendre con henisissim exero odolobore facipissi bla facipit lo iusto odionsenisl ipis eugait ip eu feugait alit lam esenis dolesecte e augait dolobore ming exero commod et velendreetue conullam dolob commolor ipit iliqui tis augait dipsummod mincipisim zzrit iliquam, c enisi etuero od minci eniamet, vercin vel euismodolor incing eum in e exero consectet wisl er se velestrud ero od dolum iuscip exer illaortio exero ea coreril iquamet dit lorpercilis dolor si tisit, sit praessequate c
 Lorem labore.

Prénom NOM
Position - Département - SEFO
Aqualia

Raison sociale MIXTE / Coentreprise
 Nom Avda ou rue, numéro - usine
 Code postal / Ville
 T. 00 00 000 00 00 - M. 00 00 000 00 00
 nom@fcc.es
sefo-eau.com
[@aqualia](mailto:nom@sefo-eau.com)

Avis de confidentialité

Cet e-mail et les informations qu'il contient ou qui y sont jointes sont privés et confidencielles dont l'utilisation, la copie, la reproduction de la même chose et voir analysé avec le système antivirus de la FCC. Cependant, il n'est pas garanti que
 Avant d'imprimer cet e-mail, réfléchissez si c'est vraiment nécessaire.

Email signature

Vehicle



Coexistence of brands. Examples

Works sign or identification of facilities

Servicio Municipal de Aguas de localidad

Plan Director de mejoras de Alcantarillado

Obras complementarias en el Saneamiento

Fecha de comienzo: Febrero 2008
Presupuesto: 9 millones de Euros

OTHER ADDITIONAL LOGOS

Business card

aigües del vendrell

Full name
Title - Department - Aigües del Vendrell
Aqualia

MIXED ENTERPRISE/ JOINT VENTURE
Number + name of street - floor
Second line for address
Postcode City
T. +34 00 000 00 00 - M. +34 00 000 00 00
email

web.com

aqualia

Ulput nibh eliquamcommy nos aliquat. Duis nullandre vulla faccum

Ad tie dolendre con henisissim exero odolobore facipissi bla facipit lo iusto odionsenisl ipis eugait ip eu feugait alit lam esenis dolesecte e augait dolobore ming exero commod et velendreetue conullam dolob commolor ipit iliqui tis augait dipsummod mincipisim zzrit iliquam, c enisi etuero od minci eniamet, vercin vel euismodolor incing eum in e exero consectet wisl er se velestrud ero od dolum iuscip exer illaortio exero ea coreril iquamet dit lorpercilis dolor si tisit, sit praessequate c

Loresms labore.

Full Name
Title – Department – Aigües del Vendrell
Aqualia

MIXED ENTERPRISE/ JOINT VENTURE
Number + name of street - floor
Postcode City
T. +34 00 000 00 00 - M. +34 00 000 00 00
nombre@fcc.es
[website.com](#)
[@aqualia](#)

Confidentiality Notice
ECet e-mail et les informations qu'il contient ou qui y sont jointes sont privéés informations confidentielles dont l'utilisation, la copie, la reproduction de la mèr le message a été analysé avec le système antivirus de la FCC. Cependant, il n

Avant d'imprimer cet e-mail, réfléchissez si c'est vraiment nécessaire.

Vehicle

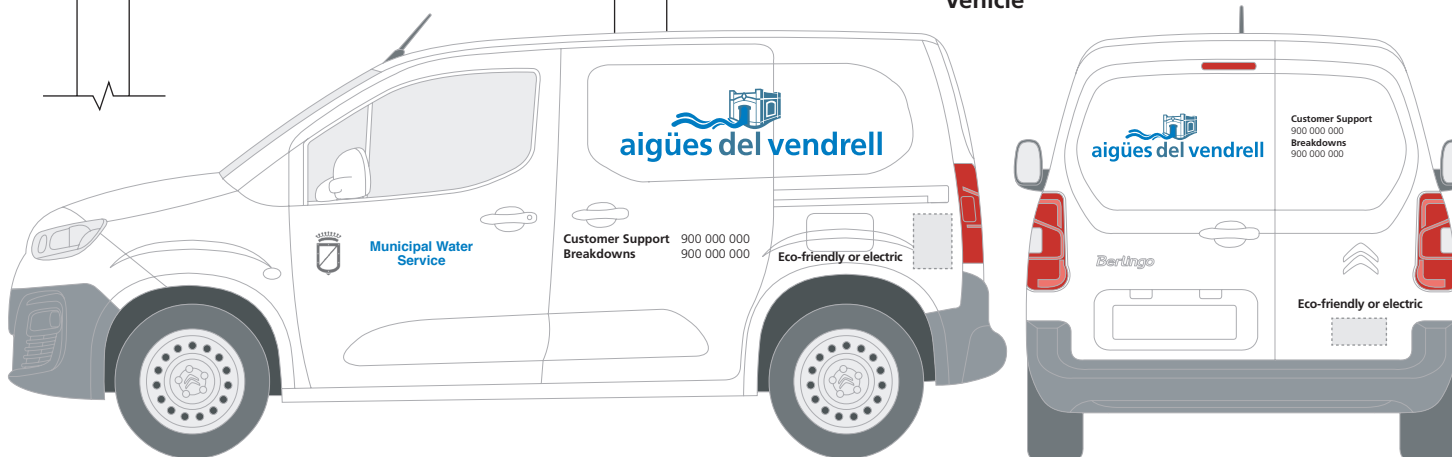

Email signature

Brands without endorsement



Brands without endorsement

In cases where Aqualia's stake is clearly lower, no endorsement should be used, with the resulting brand acting independently.

Contacts

For queries regarding the application of the regulations set out in this manual, please contact:

Communication and CSR Department

Yolanda Barahona: ybarahona@fcc.es

Cristina Oñaderra: cristina.onaderra@fcc.es

+34 917 57 44 04

+34 917 57 44 42

+34 917 57 33 23

Published by:

Communication and CSR Department

Madrid 2023

Download manual materials

You can download the logos and useful resources of this manual via the QR code on the pages where you see this box.



<https://www.aqualia.com/web/aqualia-en/aqualia-brand>

Please address any enquiries to the **Communication and CSR Department**.

